

MIRRORSTONE

LIGHTING SPECIALIST

Easilight Wallplate Remotes

Models: MS-00T1/ MS-ZONEWPB8/ MS-00T2/ MS-ZONEWPB2
MS-00T3/ MS-ZONEWPB3

1. Features

Using high-precision and capacitive touch screen IC, this remote is responsive but stable. It also makes use of the 2.4GHz frequency control methods, which ensures low power consumption, long distance transmissions, reduced interference and fast speeds.

This range has six variants in it. The MS-ZONEWPB8, the MS-ZONEWPB2 and the MS-ZONEWPB3 are each powered by 2 AAA batteries, while the MS-00T3, MS-00T2 and the MS-00T1 will need to be wired into the mains.

The MS-00T1 and MS-ZONEWPB8 will enable you to dim your lights.

The MS-00T2 and MS-ZONEWPB2 will enable you to dim your lights and control what colour temperature they are.

The MS-00T3 and MS-ZONEWPB3 will enable you to dim your lights above and also control their colour from a range of RGB options.

Please ensure you're using compatible Easilight products before continuing.

2. Specifications

For The Battery Powered Ranges:

MS-ZONEWPB8, MS-ZONEWPB2, MS-ZONEWPB3

- Working Voltage: 3V(2x AAA batteries)
- Standby Power Consumption: 20uA
- Transmitting Power: 6dBm
- Transmission Frequency: 2.4GHz
- Working Temp.: -10~40°C
- Control Distance: 30m
- Size: 86*86*16mm

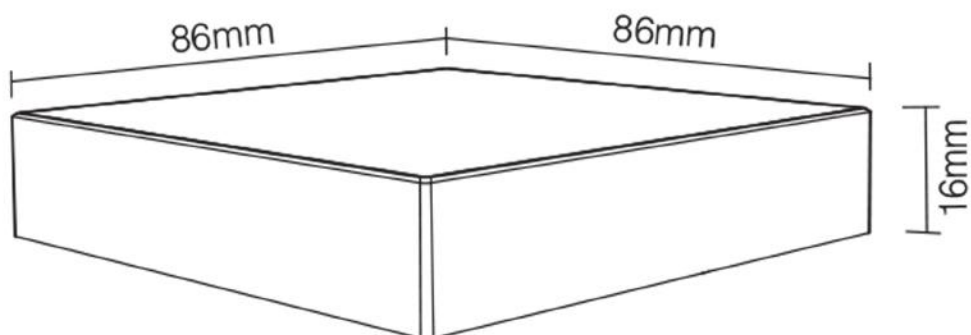

For The Mains Powered Ranges:

MS-00T1, MS-00T2, MS-00T3

- Working Voltage: AC100~240V
- Standby Power: 0.15W
- Transmitting Power: 6dBm
- Transmission Frequency: 2.4GHz
- Working Temp.: -10~40°C
- Control Distance: 30m
- Size: 86*86*31mm

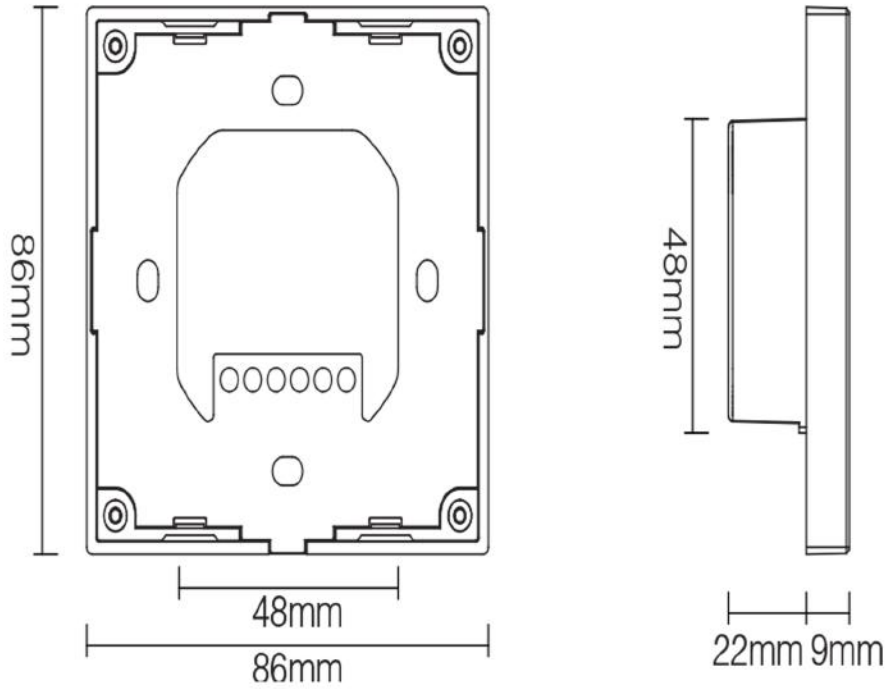

3. Function Of Keys

The following is a guide to what all the keys on each remote can do.

Note: When touching any button (except the sliders) the LED indicator will flash once and make a sound as feedback. You can turn this feature on and off by long pressing the All ON and All OFF buttons respectively.

EasiLight 4 Zone Single Colour Smart Panel Remote Controller

MS-00T1 & MS-ZONEWPB8

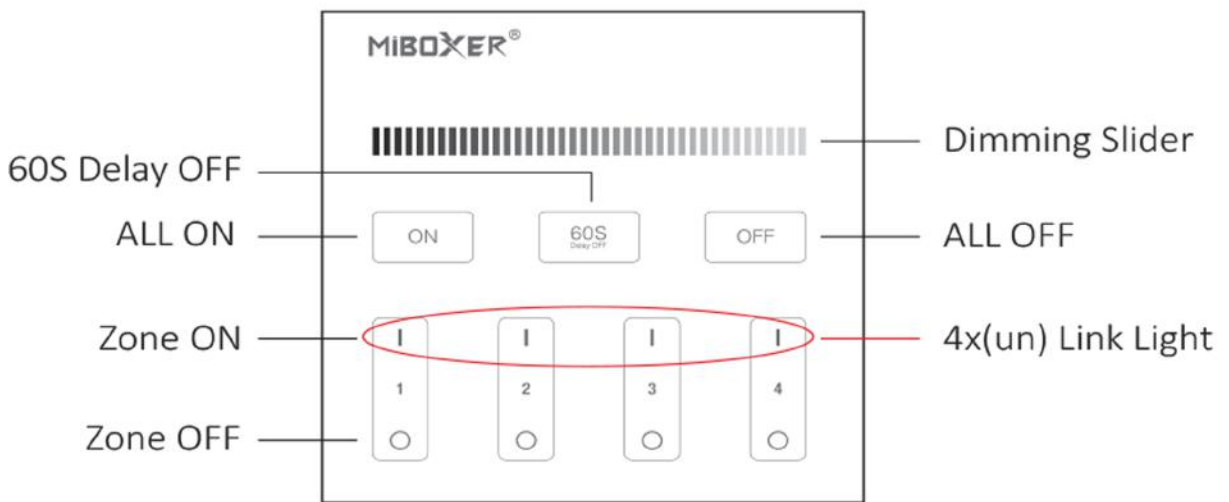

Touch the dimming slider to change brightness from 1% to 100%.



Touch the all ON button to turn on all linked lights at once.
- Long press for 5 seconds to turn ON the indicating sound



When the light is ON press the '60s Delay OFF' button to switch the lights off after a 60 second pause.



Touch the All OFF button to turn off all linked lights at once.
- Long press for 5 seconds to turn OFF the indicating sound.



Touch Zone ON to turn on all zone-linked lights.



Touch Zone OFF to turn off all zone linked lights.

EasiLight 4 Zone CCT Smart Panel Remote Controller

MS-00T2 & MS-ZONEWPB2

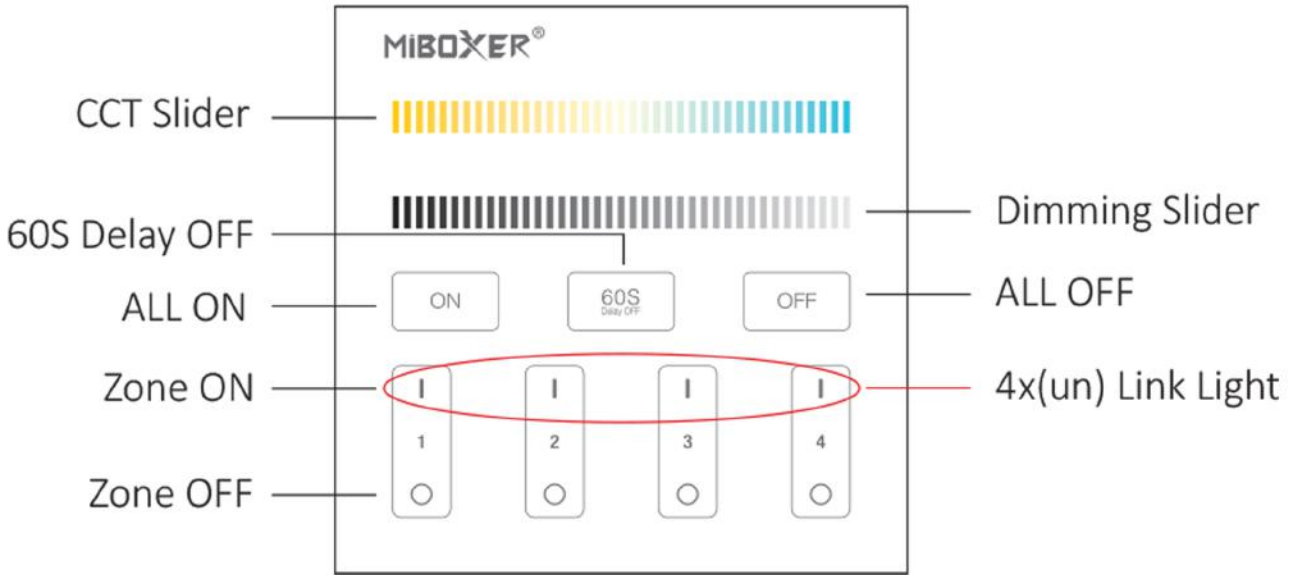

Touch the slider to change the colour temperature from warm white to cool white.



Touch the dimming slider to change brightness from 1% to 100%.



Touch the all ON button to turn on all linked lights at once.
- Long press for 5 seconds to turn ON the indicating sound.



When the light is ON press the '60s Delay OFF' button to switch the lights off after a 60 second pause.



Touch the All OFF button to turn off all linked lights at once.
- Long press for 5 seconds to turn OFF the indicating sound.



Touch Zone ON to turn on all zone-linked lights
- This button also allows you to link and unlink your lights to a specific zone, see 'Linking And Unlinking Your Remote' for more details.



Touch Zone OFF to turn off all zone linked lights.

MS-00T3 & MS-ZONEWPB3

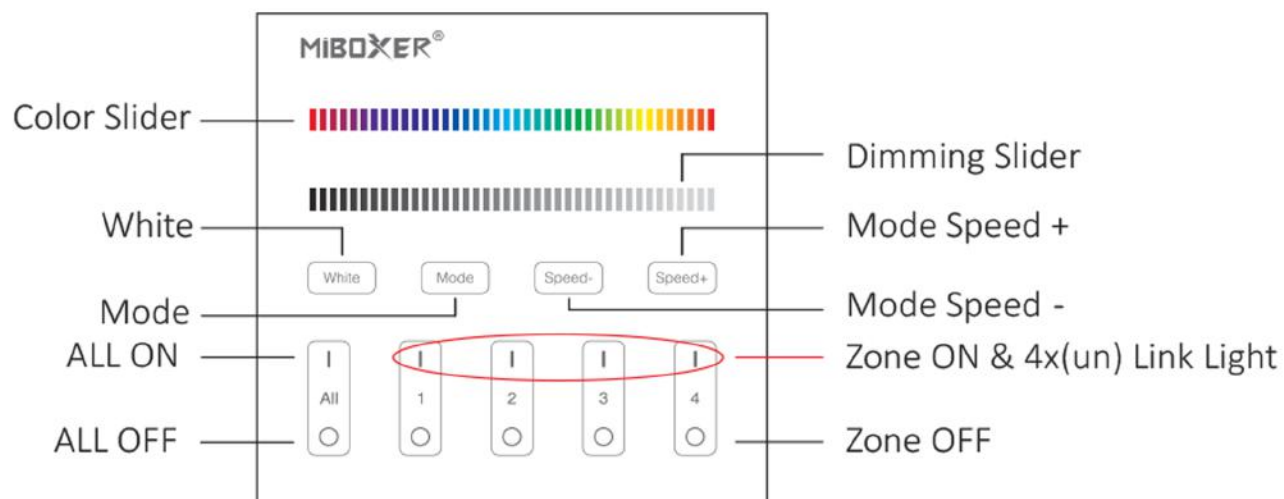

Touch the colour slider to choose the colour you want.



Touch the dimming slider to change brightness from 1% to 100%.



White

Touch the white button for white light mode.



Mode

Touch the mode button to Switch modes.



Speed-

Touch Speed- to slow the speed of the present mode.



Speed+

Touch Speed+ the accelerate the speed on the present mode.



Touch the all ON button to turn on all linked lights at once.

- Long press for 5 seconds to turn ON the indicating sound.
- Touch Zone ON to turn on all zone-linked lights
- These buttons also allow you to link your lights to a specific zone, see 'Linking And Unlinking Your Remote' for more details.



Touch the All OFF button to turn off all linked lights at once.

- Long press for 5 seconds to turn OFF the indicating sound.
- Touch Zone OFF to turn off all zone linked lights.

Easilight Zone Panel Remote (RGB+CCT)

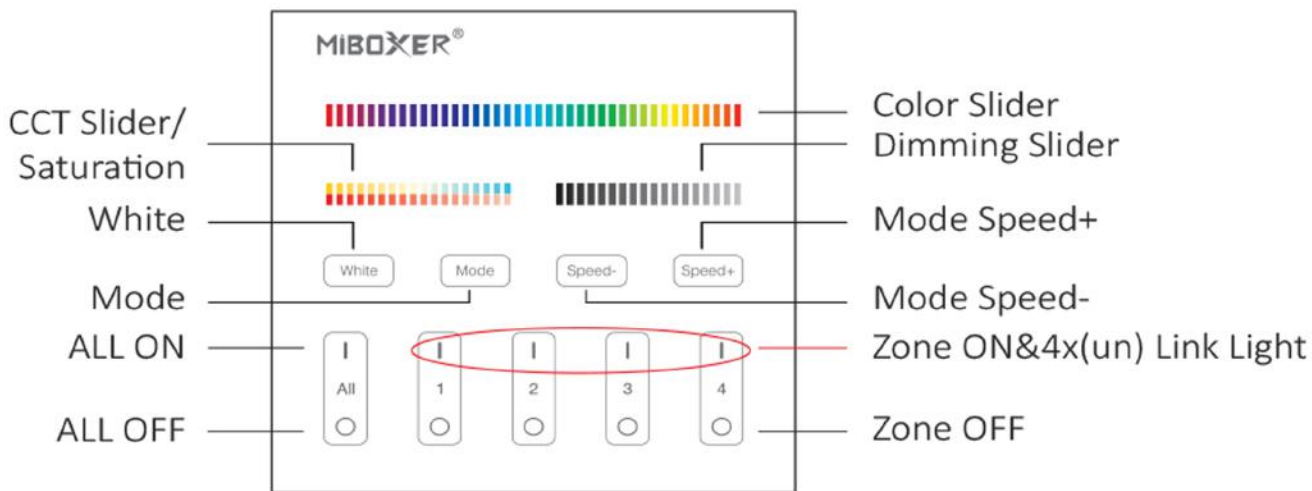

 Touch the colour slider to choose the colour you want.

 When in white light mode, this slider will adjust the colour temperature. When in colour light mode, it will change the saturation.

 Touch the dimming slider to change brightness from 1% to 100%.

 Touch the white button for white light mode.

 Touch the mode button to Switch modes.

 Touch Speed- to slow the speed of the present mode.

 Touch Speed+ the accelerate the speed on the present mode.

 Touch the all ON button to turn on all linked lights at once.
 Long press for 5 seconds to turn ON the indicating sound.
 Touch Zone ON to turn on all zone-linked lights.

 Touch the All OFF button to turn off all linked lights at once.
 - Long press for 5 seconds to turn OFF the indicating sound.
 - Touch Zone OFF to turn off all zone linked lights.

Easilight Panel Remote (RGB+CCT)

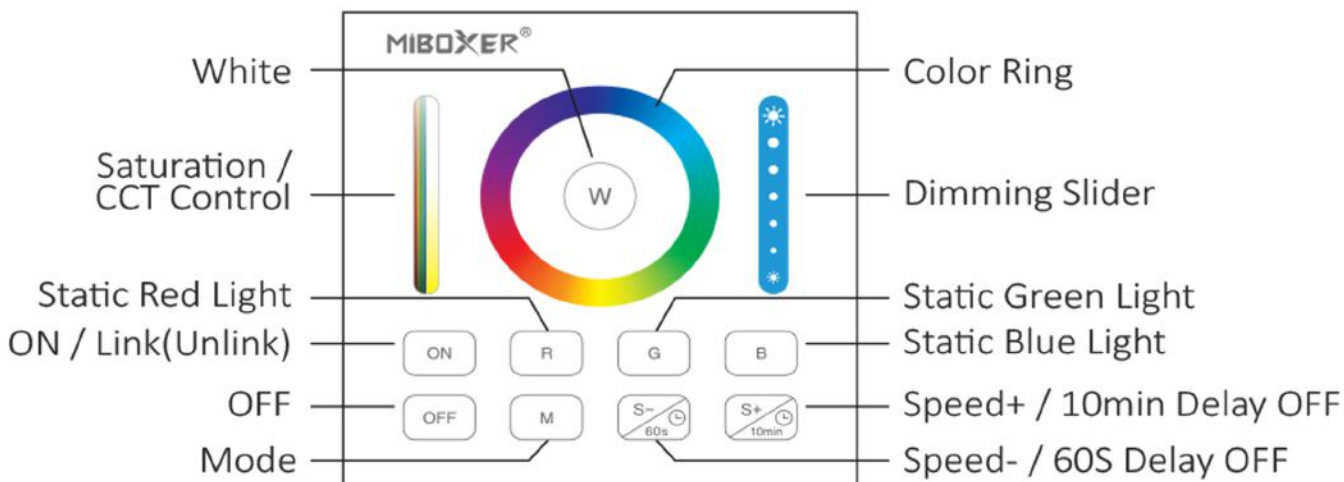

Touch the colour ring to change colours.



When in white light mode, this slider will adjust the colour temperature. When in colour light mode, it will change the saturation.



Touch this slider to adjust the brightness.



Touch this button for white light mode.



Touch the ON button to turn on the linked device.



Touch the OFF button to turn off the linked device.



Touch this button for static red light



Touch this button for static blue light



Touch this button for static green light

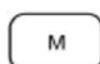

Touch this button for dynamic mode



In dynamic mode, this button will accelerate the speed.
- In static mode, long press this button for 2 seconds and your light will automatically turn off in 10 minutes.

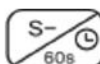

In dynamic mode, this button will slow the speed of your device.
- In static mode, long press this button for 2 seconds, and the light will automatically switch off after 60 seconds.

4. Linking And Unlinking Your Remote

Linking Instructions

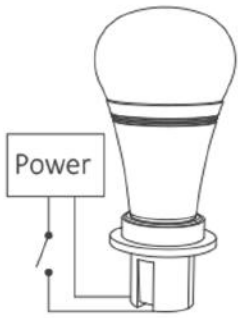

1

Switch off the light, wait 10 seconds, then switch it on again.

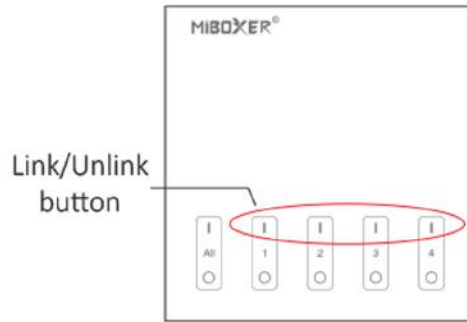

2

When the light is on, short press the indicated ON button for the desired zone 3 times within 3 seconds.

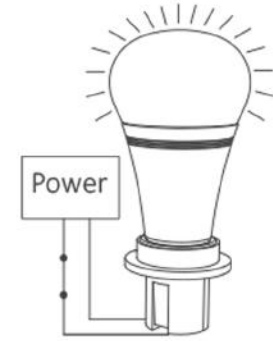

3

The light should now blink 3 times slowly to indicate a successful linking.



If the light does not blink slowly, the linking has not been successful. Please switch off the light and follow the above steps again.

Unlinking Instructions

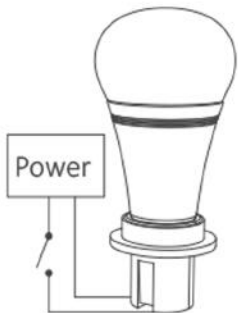

1

Switch off the light, wait 10 seconds, then switch it on again.

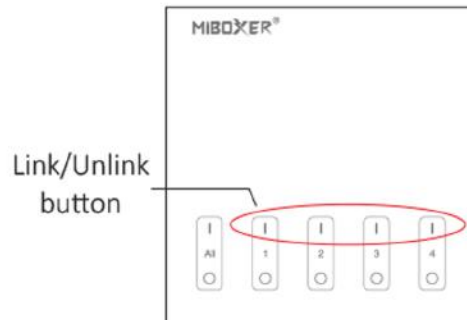

2

When the light is on, short press the indicated ON button for the desired zone 5 times within 3 seconds.

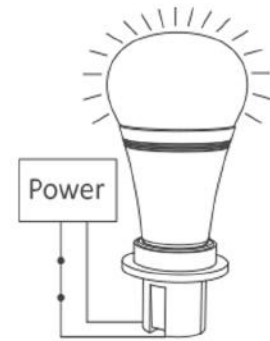

3

The light should now blink 10 times quickly to indicate a successful unlinking.



If the light does not blink quickly, the unlinking has not been successful. Please switch off the light and follow the above steps again.

(Note: To unlink your lights, you must select the same zone button the light is actually linked to)

5. Installation

If Your Remote Is Battery Operated

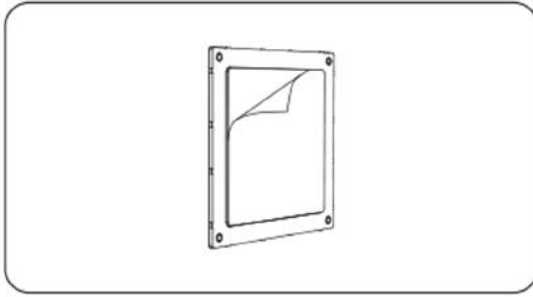

1. Tear out the back tape.

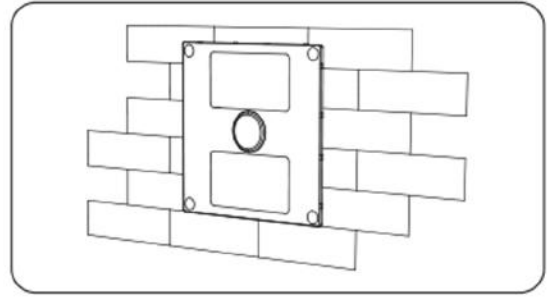

2. Stick the holder onto the wall.

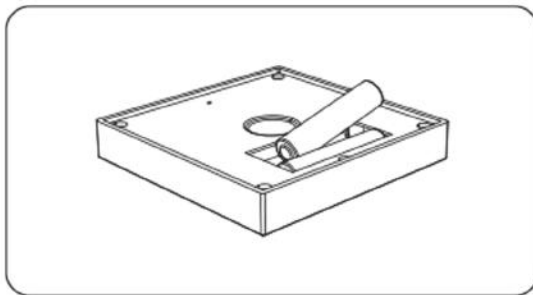

3. Install 2x AAA batteries into the main body of the remote.

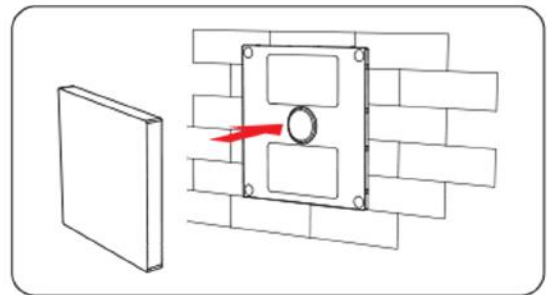

4. Place the body onto the holder.

If Your Remote Is Mains Operated

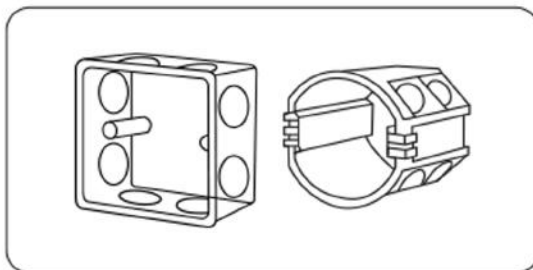

1. Install the bottom case (pictured) onto the wall.

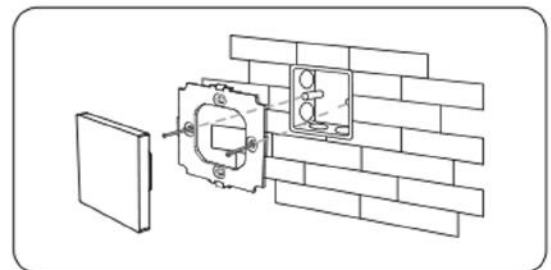

2. Fix the controller base onto the case with a screw.

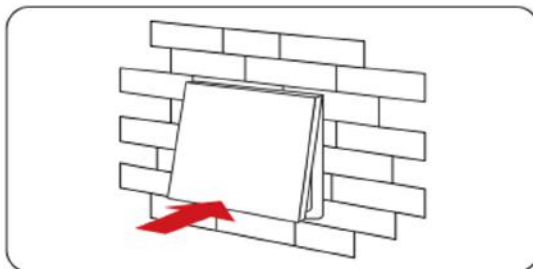

3. Click the upper side of the glass panel onto the controller base, then press the lower side until you hear it click into place.

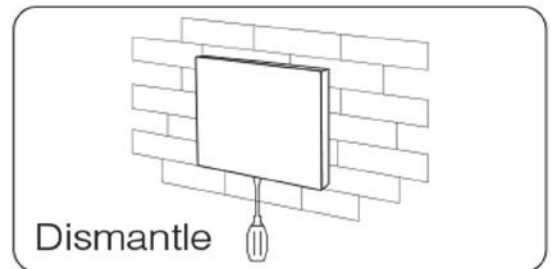

4. To dismantle your remote, use a screwdriver to gently unclick the lower side out of place.

6. Attention

1. Please check the cable and ensure the circuit is correct before switching the power on.
2. Please handle with care during installation to avoid breaking the glass surface.
3. Do not use these fixtures in areas with a high magnetic field as this will badly affect the control distance.

MIRRORSTONE
L I G H T I N G S P E C I A L I S T

sales@mirrorstone.co.uk
www.mirrorstonelighting.co.uk/
86 Scudamore Road Leicester, LE3 1UQ
+44 (0) 116 321 4121